

SULLIVANS

Item No.

Deluxe Cutting Table

Instructions

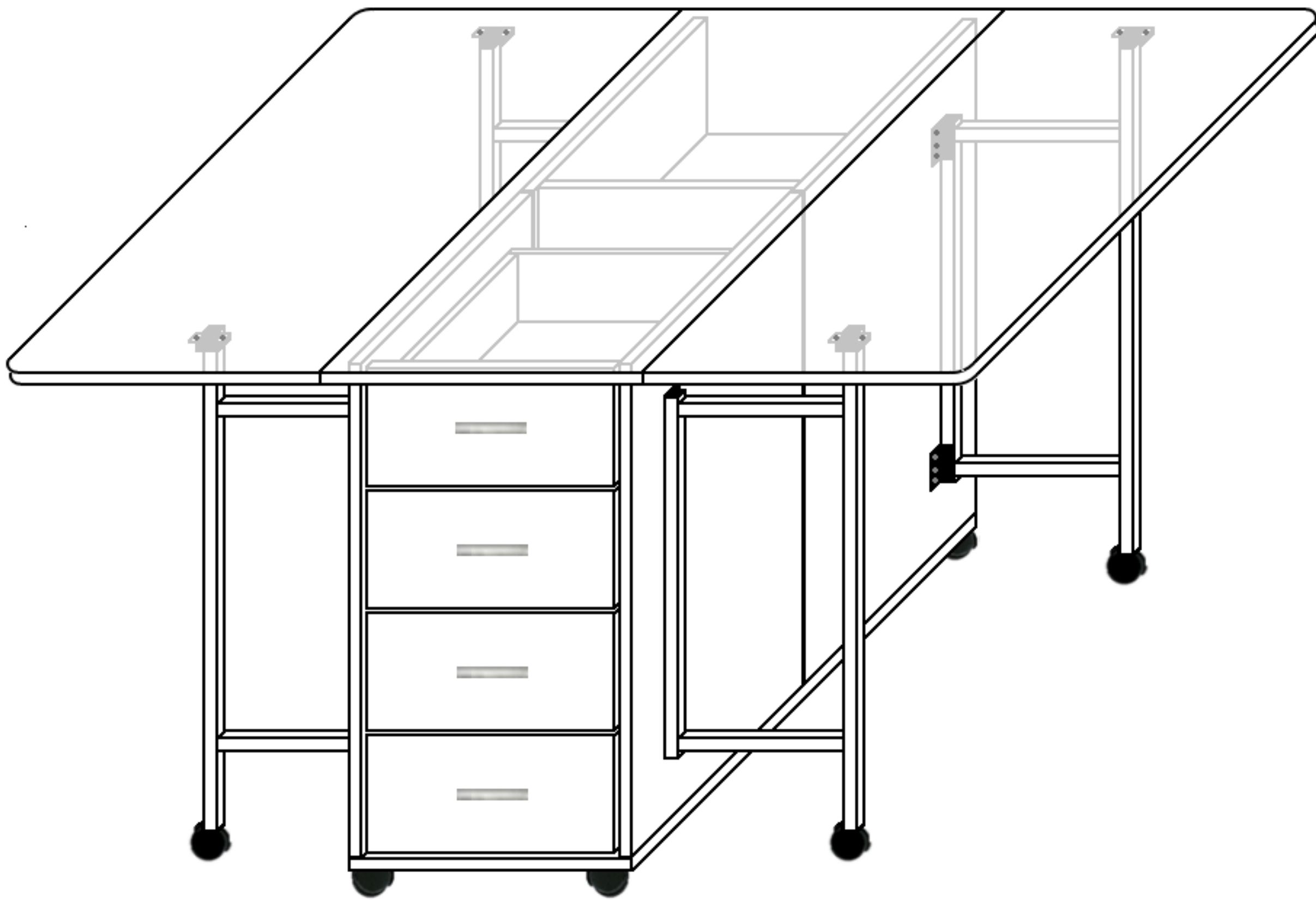

www.sullivans.net/usa











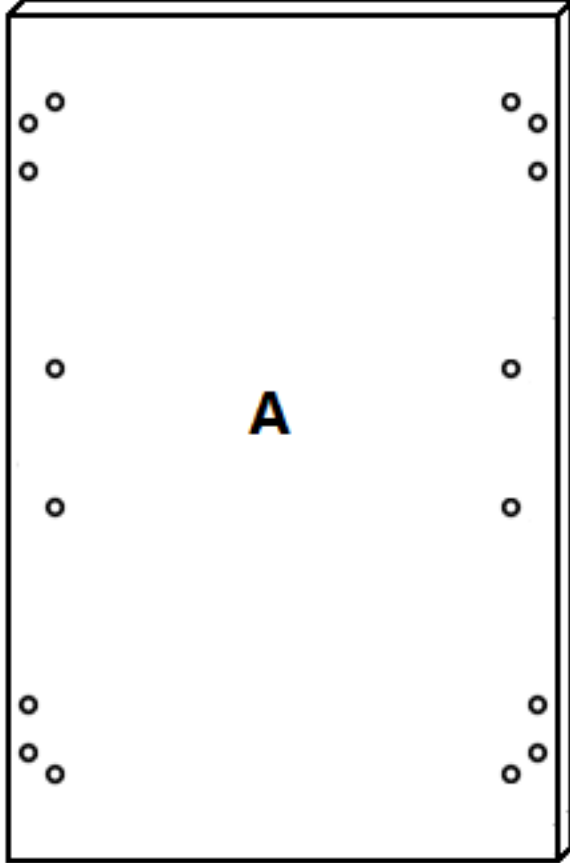
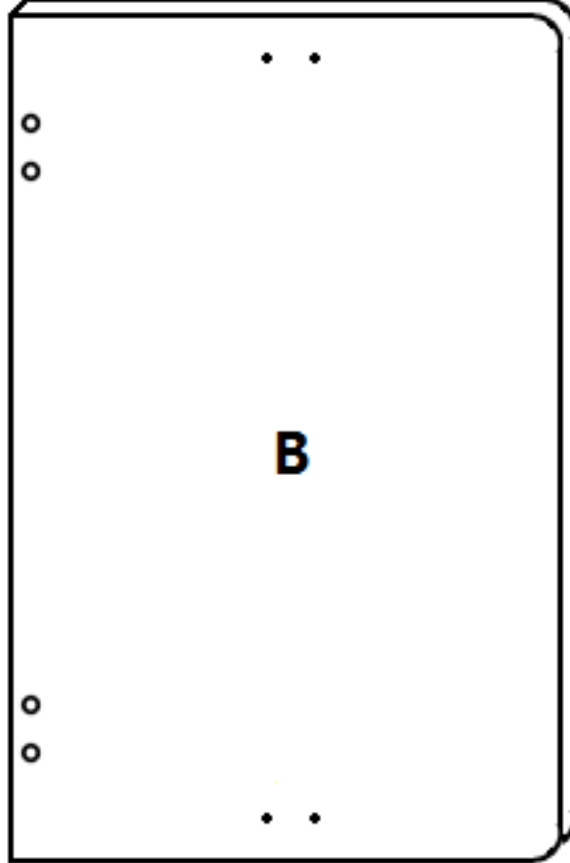
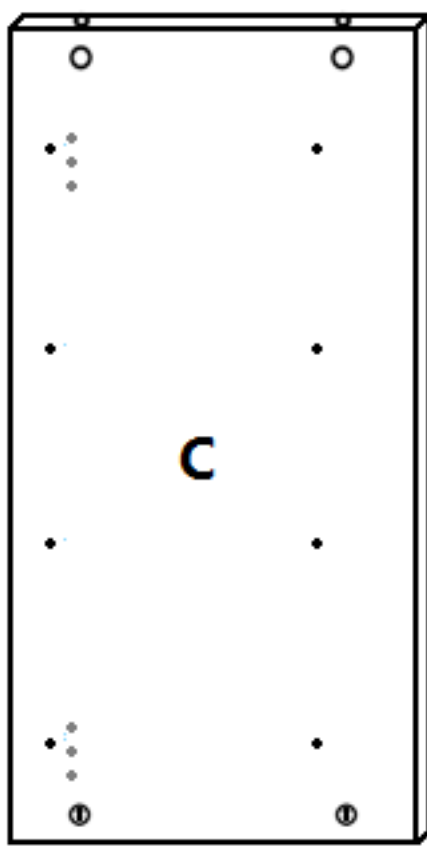
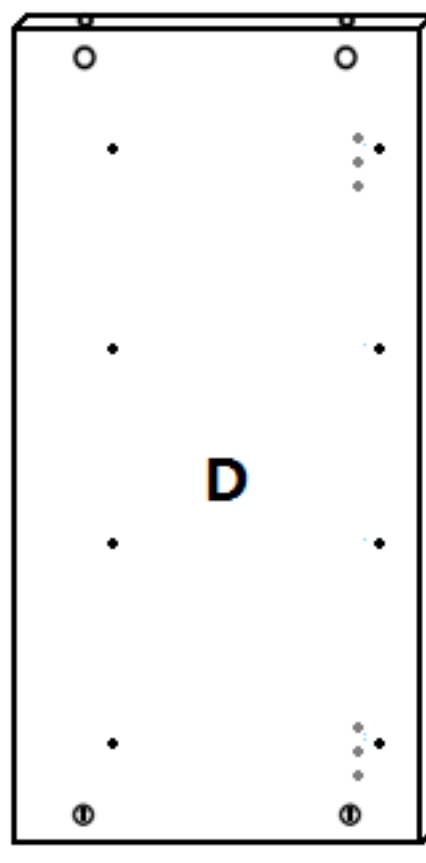
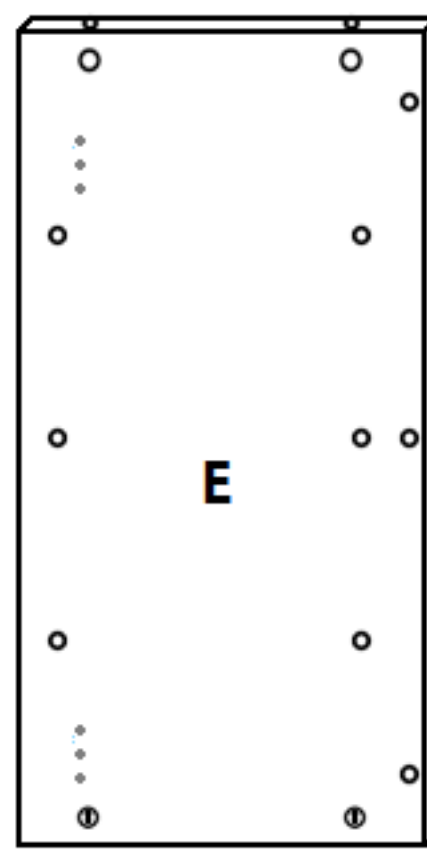
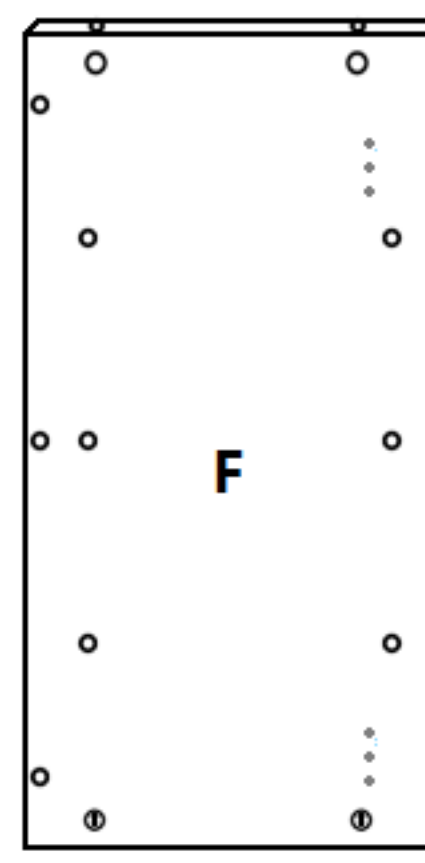
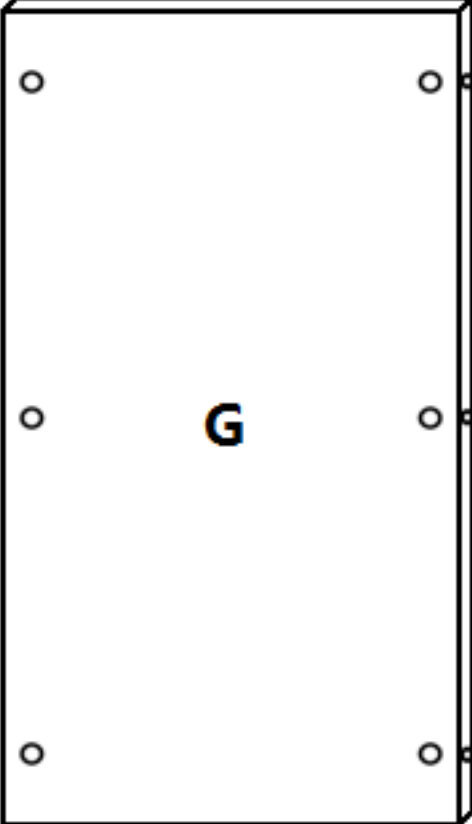
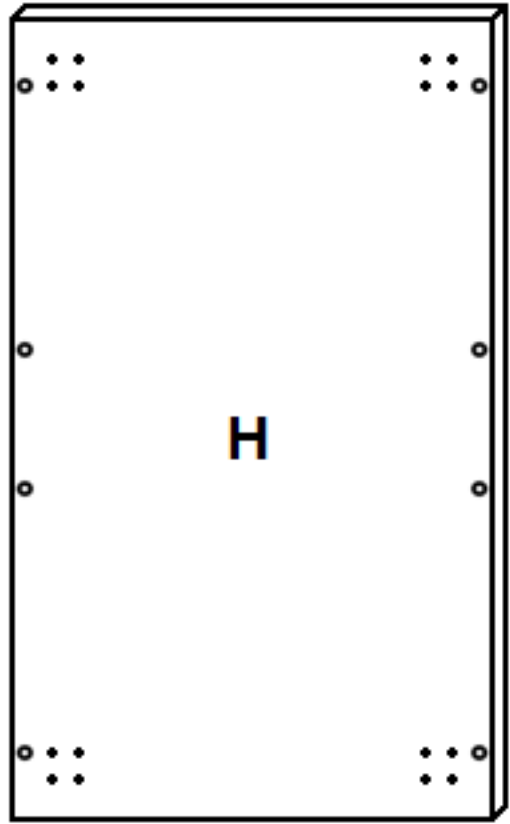
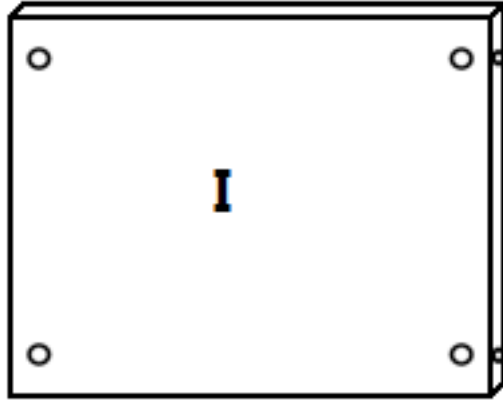
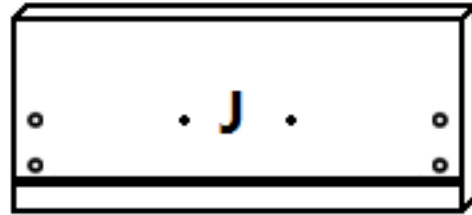
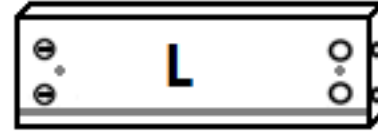
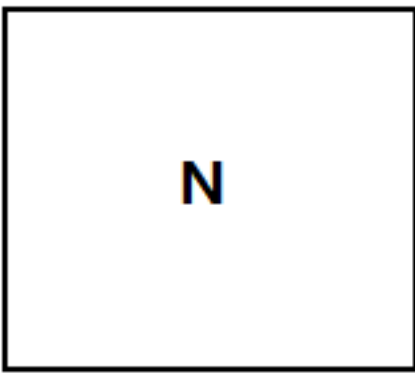
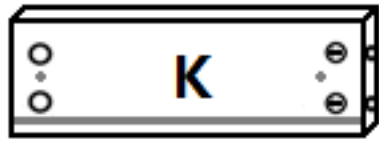
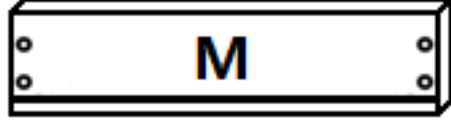





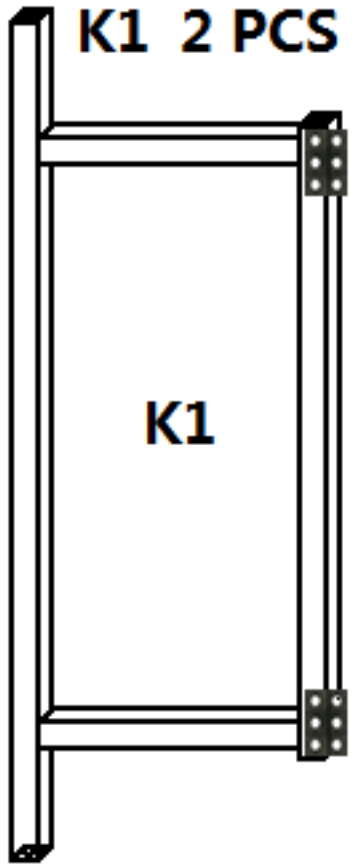
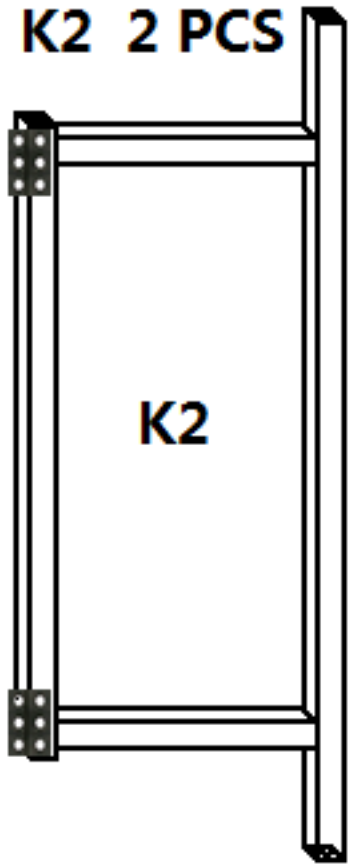

Tools needed:

Phillips Head screwdriver.

Assembly Time:

App. 80 minutes



<p>A 1PC</p>  <p>A</p> <p>Table Top</p>		<p>B 2PCS</p>  <p>B</p> <p>Table Top</p>		<p>C 1PC</p>  <p>C</p> <p>Left Side Panel</p>		<p>D 1PC</p>  <p>D</p> <p>Right Side Panel</p>		<p>E 1PC</p>  <p>E</p> <p>Left Side Panel</p>		<p>F 1PC</p>  <p>F</p> <p>Right Side Panel</p>	
<p>G 1PC</p>  <p>G</p> <p>Back Panel</p>		<p>H 1PC</p>  <p>H</p> <p>Bottom Panel</p>		<p>I 3PCS</p>  <p>I</p> <p>Partition Panel</p>		<p>J 4PCS</p>  <p>J</p> <p>Front Panel For Drawer</p>		<p>L 4PCS</p>  <p>L</p> <p>Right Side Drawer Panel</p>		<p>N 4PS</p>  <p>N</p> <p>Bottom Board For Drawer</p>	
<p>K 4PCS</p>  <p>K</p> <p>Left Side Drawer Panel</p>		<p>M 4PS</p>  <p>M</p> <p>Back Panel For Drawer</p>		<p>① 56 PCS ② 16 PCS ③ 24 PCS ④ 16 PCS ⑤ 8 PCS ⑥ 4 PCS ⑦ 4 PCS</p>        <p>3.5*12 Screws 3.5*14 Screws 5*50 Screws 6*10 Screws 3*12 Screws Magnet Hinges</p>							
<p>K1 2 PCS</p>  <p>K1</p> <p>Support Panel</p>		<p>K2 2 PCS</p>  <p>K2</p> <p>Support Panel</p>		<p>⑧ 4 PCS ⑨ 4 PCS ⑩ 42 PCS ⑪ 42 PCS ⑫ 8 PCS ⑬ 4 PCS ⑭ 8 PCS ⑮ 1 PS ⑯ 1 PS</p>          <p>Caster Caster Cam-bolt Cam-lock Screws Handle Slider Allen Key Allen Key</p>							

Step 1A, Use part #4 Screws to screw the part

#7 Hinges onto table top A & B.

Step 1B, Screw the part #10 Cam-bolt into

Table Top A & B.

Step 1C, Use part #5 Screws to screw the part

#6 Magnet onto Table Top B.

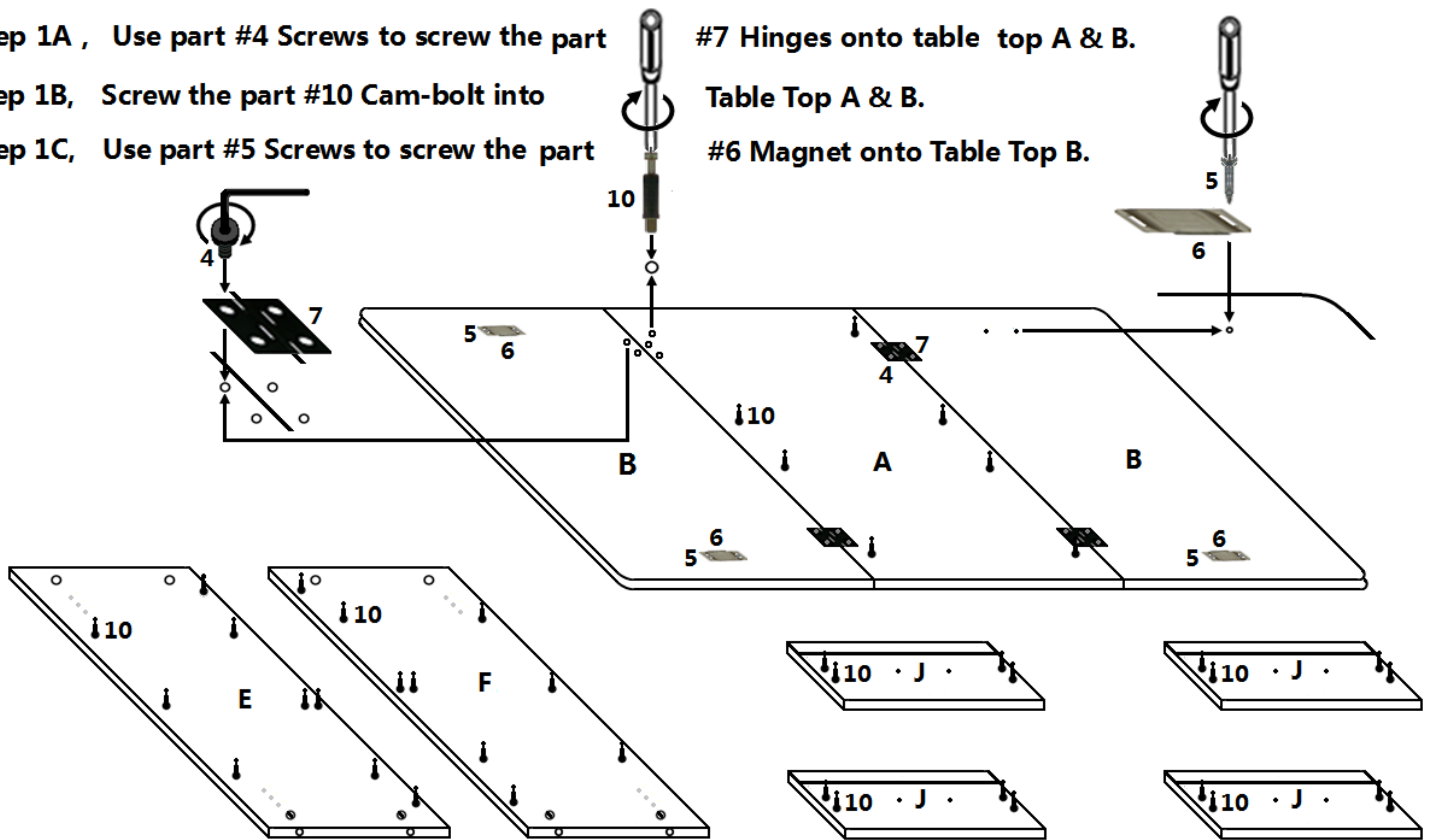

Step 2A, Rotate the part #11 Cam-locks left and right and press them into panel C, D, E, F, G, I, K and L.

Step 2B, Press the locking block of the part #14 Slider, pull out the inner Slider, use part #1 Screws to screw the outer sliders onto the panel C & D, and use part #1 Screws to screw the inner sliders onto the panel K & L.

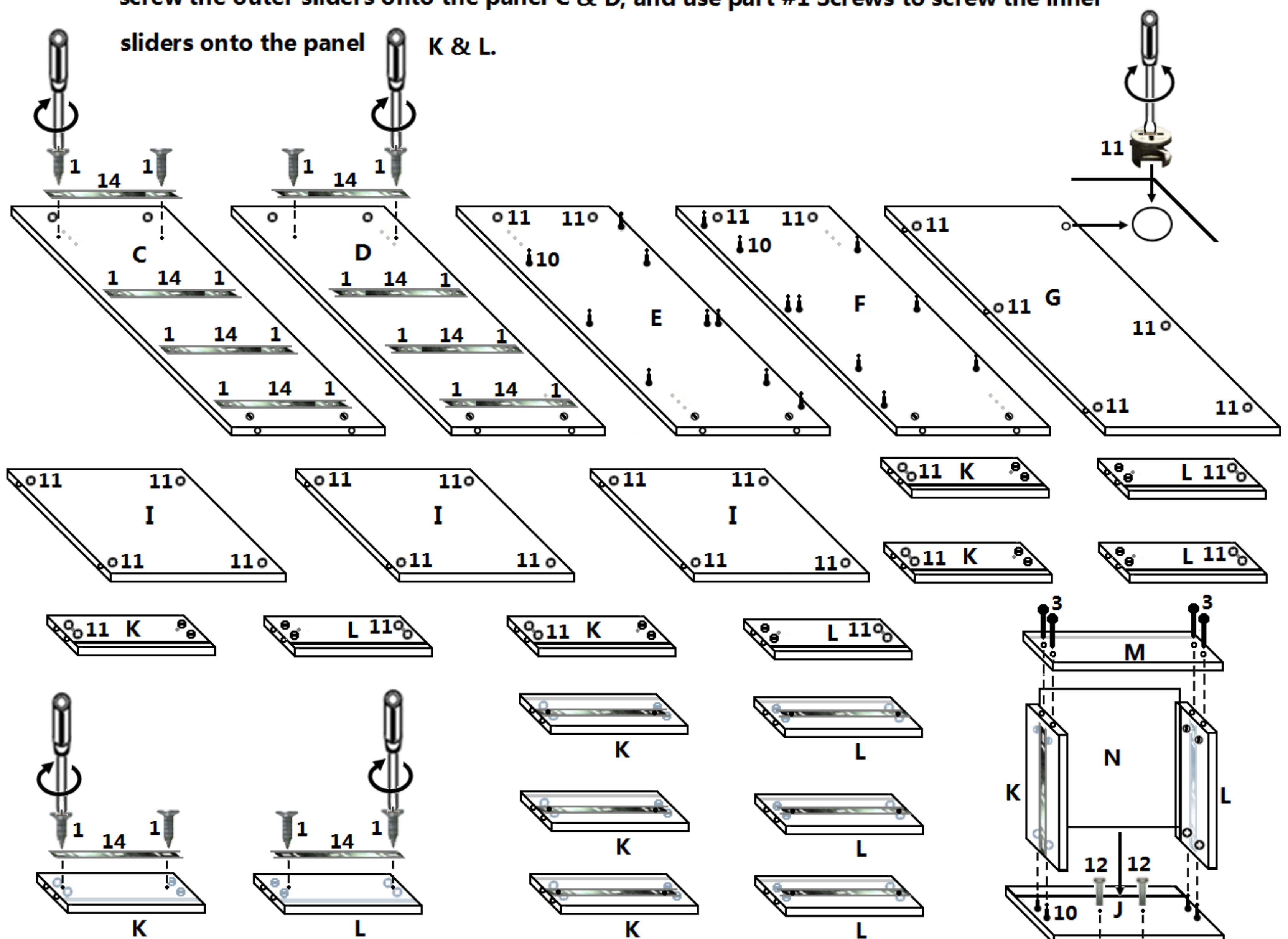

Step 3, Insert the part #11 Cam-locks on Panel K & L into the part #10 Cam-bolts on the Panel J, insert panel N into the slots of panel K, L and J, and tighten these Cam-locks clockwise. Use part #3 Screws to screw the panel M with panel K & L, use part #12 Screw to screw the part #13 onto panel J.

Step 4A, Insert the part #11 Cam-locks on Panel G & I into the part #10 Cam-bolts on the panel F, Insert the part #10 Cam-bolts on Panel E into the part #11 Cam-locks on the Panel G & I, and tighten these Cam-locks clockwise.

Step 4B, Insert the part #11 Cam-locks on the Panel C, D, E and F into the part #10 Cam-bolts on the Table Top A, and tighten these Cam-locks clockwise.

Step 4C , Use part #3 Screws to screw the panel H with panel C, D, E and F, use part #2 Screws to screw the part #9 Casters onto the panel H.

